

Copyright

Fujitsu Limited has made every effort to ensure the accuracy and completeness of this document. However, as ongoing development efforts are continually improving the capabilities of our products, we cannot guarantee the accuracy of the contents of this document. We disclaim liability for errors, omissions or future changes.

LIFEBOOK is a trademark of Fujitsu Limited.

Microsoft, Windows, MS, , Windows 7, Windows 8.1 and Windows 10 are registered trademarks of the Microsoft Corporation of the United States in the United States and other countries.

Phoenix is a registered trademark of Phoenix Technologies Corporation of the United States.

Copyright© Microsoft Corporation 2016, All rights reserved.

Copyright© Phoenix Technologies, Ltd. 2016, All rights reserved.

Other product names are trademarks or registered trademarks of their respective companies.

Copyright Fujitsu Limited © 2016. All rights reserved. No part of this publication may be copied, reproduced or translated, without the prior written consent of Fujitsu Limited. No part of this publication may be stored or transmitted in any electronic form without the written consent of Fujitsu Limited.

This device complies with Part 15 of the FCC rules. Operations are subject to the following two conditions:

- (1) This device may not be allowed to cause harmful interference.
- (2) This device must accept any interference received, including interference that may cause undesired operation.

Website: <http://hk.fujitsu.com/pc>



DECLARATION OF CONFORMITY
according to FCC Part 15



IMPORTANT SAFETY INSTRUCTIONS

1. Read these instructions carefully. Save these instructions for future reference.
2. Follow all warnings and instructions marked on the product.
3. Unplug this product from the wall outlet before cleaning. Do not use liquid cleaners or aerosol cleaners. Use a damp cloth for cleaning.
4. Do not use this product near water.
5. Do not place this product on an unstable cart, stand or table. The product may drop, causing serious damage to the product.
6. Slots and openings in the cabinet and the back or bottom are provided for ventilation; to ensure reliable operation of the product and to protect it from overheating, these openings must not be blocked or covered. The openings should never be blocked by placing the product on a bed, sofa, rug or other similar surface. This product should never be placed near or over a radiator or heat register or in a built-in installation unless proper ventilation is provided.
7. This product should be operated from the type of power indicated on the marking label. If you are not sure of the type of power available, consult your dealer or local power company.
8. Do not allow anything to rest on the power cord. Do not locate this product where persons will walk on the cord.
9. If an extension cord is used with this product, make sure that the total ampere rating of the equipment plugged into the extension cord does not exceed the extension cord ampere rating. Also make sure that the total rating of all products plugged into the wall outlet does not exceed 15 amperes.
10. Never push objects of any kind into this product through cabinet slots as they may touch dangerous voltage points that could result in a fire or electric shock. Never spill liquid of any kind on the product.
11. Do not attempt to service this product yourself, as opening or removing covers may expose you to dangerous voltage points or other risks. Refer all servicing to qualified service personnel.
12. Unplug this product from the wall outlet and refer servicing to qualified service personnel under the following conditions:
 - a. When the power cord or plug is damaged or frayed.
 - b. If liquid has been spilled into the product.
 - c. If the product has been exposed to rain or water.
 - d. If the product does not operate normally when the operating instructions are followed. Adjust only those controls that are covered by the operating instructions since improper adjustment of other controls may result in damage and will often require extensive work by a qualified technician to restore the product to normal condition.
 - e. If the product has been dropped or the cabinet has been damaged.
 - f. If the product exhibits a distinct change in performance, indicating a need for service.

13. **CAUTION:** When replacing the battery, be sure to install it with the polarities in the correct position. There is a danger of explosion if the battery is replaced with an incorrect type or is mistreated. Do not recharge, disassemble or dispose of in fire. Replace only with the same or equivalent type recommended by the manufacturer. Dispose of the used battery according to the manufacturer's instructions.
14. Use only the proper type of power cord set (provided in the accessories box) for this unit. It should be detachable type and with respective certification.



POINT

The point icon highlights information that will enhance your understanding of the subject material.



CAUTION

The caution icon highlights information that is important to the safe operation of your computer, or to the integrity of your files. Please read all caution information carefully.



WARNING

The warning icon highlights information that can be hazardous to either you, your computer, or your files. Please read all warning information carefully.

 **CAUTION**

- Changes or modifications not expressly approved by Fujitsu could void this user's authority to operate the equipment.

FCC NOTICES

Notice to Users of Radios and Television

These limits are designed to provide reasonable protection against harmful interference in a residential installation. This equipment generates, uses, and can radiate radio frequency energy and, if not installed and used in accordance with the instructions, may cause harmful interference to radio communications. However, there is no guarantee that interference will not occur in a particular installation. If this equipment does cause harmful interference to radio or television reception, which can be determined by turning the equipment off and on, the user is encouraged to try to correct the interference by one or more of the following measures:

- Reorient or relocate the receiving antenna.
- Increase the separation between the equipment and receiver.
- Connect the equipment into an outlet that is on a different circuit than the receiver.
- Consult the dealer or an experienced radio/TV technician for help.

Shielded interconnect cables must be employed with this equipment to ensure compliance with the pertinent RF emission limits governing this device.

Notice to Users of the US Telephone Network*

Your Stylistic maybe supplied with an internal modem which complies with Part 68 of the FCC rules. On this Tablet PC is a label that contains the FCC Registration Number and the Ringer Equivalence Number(REN) for this equipment

among other information. If requested the user must provide their telephone company with the following information:

1. The telephone number to which the Tablet PC is connected.
2. The Ringer Equivalence Number(REN) for this equipment.
3. That the equipment requires a standard modular jack type USOC RJ-11C which is FCC Part 68 compliant.
4. The FCC Registration Number.

This equipment is designed to be connected to the telephone network or premises wiring using a standard modular jack type USOC RJ-11C which is FCC Part 68 68 compliant and a line cord between the modem and the telephone network with a minimum of 26AWG.

The REN is used to determine the number of devices that you may connect to your telephone line and still have all of those devices ring when your number is called. Too many devices on one line may result in failure to ring in response to an incoming call. In most, but not all, areas the sum of the RENs of all of the devices should not exceed five(5). To be certain of the number of devices you may connect to your line, as determined by the RENs, contact your local telephone company.

If this equipment causes harm to the telephone network your telephone company may discontinue your service temporarily. If possible, they will notify you in advance. If advance notice is not practical they will notify you as soon as possible. You will also be advised of your right to file a complaint with the FCC.

This fax modem also complies with fax branding requirements per FCC Part 68.

Your telephone company will probably ask you to disconnect this equipment from the telephone network until the problem is corrected and you are sure that the equipment is not malfunctioning.

*For model with modem only

This equipment may not be used on telephone provided by your telephone company. Connection to party lines is subject to state tariffs. Contact your state's public utility commission, public service commission or corporation commission for more information.

This equipment includes automatic dialing capability. When programming and/or making test calls to emergency numbers:

- Remain on the line and briefly explain to the dispatcher the reason for the call.
- Perform such activities in off-peak hours, such as early morning or late evening.

FCC rules prohibit the use of non-hearing aid compatible telephones in the following locations or applications:

- All public or semipublic coin-operated or credit card telephones.
- Elevators, highways, tunnels (automobile, subway, railroad or pedestrian) where a person with impaired hearing might be isolated in an emergency.
- Places where telephones are specifically installed to alert emergency authorities such as fire, police or medical assistance personnel.
- Hospital rooms, residential health care facilities, convalescent homes and prisons.
- Workstations for the hearing impaired.
- Hotel, motel or apartment lobbies.
- Stores where telephones are used by patrons to order merchandise.
- Public transportation terminals where telephones are used to call taxis or to reserve lodging or rental cars.
- In hotel and motel rooms as at least ten percent of the rooms must contain hearing aid compatible telephones or jacks for plug-in hearing aid compatible telephones which will be provided to hearing impaired customers on request.

DOC (INDUSTRY CANADA) NOTICES

Notice to Users of Radios and Television

This Class B digital apparatus meets all requirements of the Canadian Interference Causing Equipment Regulations.

Notice to Users of the Canadian Telephone Network*

The Canadian Industry Canada label identifies certified equipment. This certification means that the equipment meets certain telecommunications network protective, operational, and safety requirements. The Department does not guarantee the equipment will operate to the user's satisfaction.

Stylistic is supplied with an internal modem complies which complies with the Industry Canada certification standards for telecommunication network protection and safety requirements. Before connecting this equipment to a telephone line the user should ensure that it is permissible to connect this equipment to the local telecommunication facilities. The user should be aware that compliance with the certification standards does not prevent service degradation in some situations.

Repairs to telecommunication equipment should be made by a Canadian authorized maintenance facility. Any repairs or alterations not expressly approved by Fujitsu or any equipment failures may give the telecommunication company cause to request the user to disconnect the equipment from the telephone line.

The connecting arrangement code for this equipment is CA11A.

The Load Number assigned to each telephone terminal device denotes the percentage of the total load to be connected to a telephone loop or circuit which is used by the device to prevent overloading. The termination on a loop may consist of any combination of devices such that the total of the load numbers of all devices does not exceed 100.

* For model with modem only



ENERGY STAR® Compliance Notice to Users of Radios and Television

(The following is pending certification at time of publication). Your Fujitsu system is an ENERGY STAR® qualified mobile PC. By choosing a computer with the latest energysaving technology, you're helping to preserve our environment for future generations. ENERGY STAR is a joint program of the U.S. Environmental Protection Agency, U.S. Department of Energy, Natural Resources Canada, and other governments around the world helping us save money while protecting the environment through energy efficient products and practices. With energy costs and global warming top-of-mind for consumers, Fujitsu is committed to offering solutions that help consumers conserve energy and improve the quality of our environment.

Sleep Mode:

You will notice that your computer is initially set so that the display turns off after 15 minutes of user inactivity, and the computer goes into Sleep mode after 20 minutes of user inactivity. When going into Sleep mode, the computer also reduces the speed of any active Ethernet network links. To "wake" the computer from Sleep mode, press the Suspend/ Resume Button.

Energy saving benefits:

Fujitsu ENERGY STAR qualified mobile PCs use about half as much electricity as standard equipment – saving half in utility costs. But more than that, ENERGY STAR also makes a difference for the environment. Did you know that the average house can be responsible for twice the greenhouse gas emissions as the average car? That's because every time you flip on a light switch, run your dishwasher, or turn on your PC, you use energy, which means more greenhouse gas emissions from power plants. So the more energy we can save through energy efficiency, the more we help to reduce greenhouse gases and the risks of global warming. To learn more about the important ENERGY STAR program, visit: www.energystar.gov.

CAUTION

- For safety, users should ensure that the electrical ground of the power utility, the telephone lines and the metallic water pipes are connected together. Users should NOT attempt to make such connections themselves but should contact the appropriate electric inspection authority or electrician. This may be particularly important in rural areas.

UL Notice

This unit requires an AC adapter to operate. Use only UL Listed adapter, output rating 19VDC, 3.42A*. Refer to the illustration below for the correct AC Adapter output polarity:

* Please check with local distributor for actual bundling.



CAUTION

- To reduce the risk of fire, use only #26 AWG or larger telecommunications line cord.

For Authorized Repair Technicians Only

CAUTION

- For continued protection against risk of fire, replace only with the same type and rating fuse.

WARNING

- Danger of explosion if Lithium (CMOS) battery is incorrectly replaced. Replace only with the same or equivalent type recommended by the manufacturer. Dispose of used batteries according to the manufacturer's instruction.

Proper Disposal of Battery

Under federal, state or local law, it may be illegal to dispose of batteries by putting them in the rubbish bins or trash cans. Please take care of our environment and dispose of batteries properly for details regarding recycling or disposing of unwanted batteries.



NOTE ON USE REQUIRED HIGH SAFETY

Notice to Users of Radios and Television

This product is designed and manufactured for general use, household use and ordinary industrial use.

This product is not designed for or intended for use under dangerous (fatal) conditions, unless extreme safety precautions are implemented.

Do not use this product without implementing high-level safety precautions.

Failure to follow this warning may result in death, personal injury, severe physical damage or other loss, if used in or near any or more of the following:

- nuclear reaction control system in a nuclear facility
- automatic flight control system in an airplane or other flight control system
- mass transport control system
- medical instruments for life support system
- missile launching control for weapon system

NOTE ON BACKUP DATA

Please make a backup of the Operating System, any software programs, and created files (and update regularly).

If you send this product to Fujitsu, or any of its affiliates, suppliers, service providers or resellers for repair, Fujitsu does not guarantee the data integrity. It is your responsibility to back data up beforehand.

Fujitsu does not assume any obligation for compensation for damages, data integrity, or restoration, etc., if your data is lost for any reason, except as written in the warranty.

AUSTRALIAN REGULATIONS

Important Health and Safety Information

This STYLISTIC Tablet PC complies with the relevant safety regulations for data processing equipment. If you have questions about using your Tablet PC in a particular area, please contact your sales outlet or our Hotline/Help Desk.

Additional safety notes for devices with modem

WARNING

FOR SAFETY REASONS, ONLY CONNECT EQUIPMENT WITH A TELECOMMUNICATIONS COMPLIANCE LABEL. THIS INCLUDES CUSTOMER EQUIPMENT PREVIOUSLY LABELLED PERMITTED OR CERTIFIED.

Connection of Non Certified/ Approved peripherals may result in the equipment operating outside the Australian EMI Standards.

Modems connected to the Australian telecommunications network must be operated in accordance with the Labelling Notice. This modem has been specifically configured to ensure compliance with the ACMA standards. Do not adjust your modem or software outside the values indicated below. To do so would result in your modem being operated in a non-compliant manner.

The unit shall be connected to Telecommunications Network through a line cord, which meets the requirements of ACMA AS/ ACIF S008:2006.

The equipment shall be powered through an Australian Approved mains cord set. When the Secondary Landscape Orientation of the Tablet PC is held close to the body, the antenna must be in closed condition to avoid physical damage to the Antenna.

Call Attempts / Retries:

Applications software shall be configured so that no more than 3 attempts are made to establish a connection to a given number (Note: if the modem can detect service tones, up to 10 attempts can be made). If the call sequence is unsuccessful, there shall be a delay of at least 30 minutes before attempting to call the number again.

Failure to set the modem and any application software used with the modem, to the values shown above will result in the modem being operated in a non-compliant manner. Consequently, this would be in violation of the Labelling Notice for 1997 prescribes penalties for the connection of non-complaint equipment.

NEW ZEALAND WARNINGS

The grant of a Telepermit for any item of terminal equipment indicates only that Telecom has accepted that the item complies with minimum conditions for connection to its network. It indicates no endorsement of the product by Telecom, nor does it provide any sort of warranty. Above all, it provided no assurance that any item will work correctly in all respects with another item of Telepermitted equipment of a different make or model, nor does it imply that any product is compatible with all of Telecom's network services.

This equipment is not capable under all operating conditions of correct operation at the higher speeds for which it is designed. 56 KBPS connections are likely to be restricted to lower bit rates when connected to some PSTN implementations. Telecom will accept no responsibility should difficulties arise in such circumstances.

Immediately disconnect this equipment should it become physically damaged, and arrange for this disposal or repair.

This equipment shall not be used in any manner, which could constitute a nuisance to other Telecom customers.

This equipment shall not be set to make automatic calls to the Telecom "111" Emergency Service.

This device is equipped with pulse dialing while the New Zealand standard is DTMF tone dialing. There is no guarantee that Telecom lines will always continue to support pulse dialing. It is strongly recommended that pulse dialing is not used.

Some parameters required for compliance with Telecom's Telepermit requirements are dependent on the equipment (PC) associated with this device. The associated equipment shall be set to operate within the following limits for compliance with Telecom's Specifications:

For repeat calls to the same number.

There shall be no more than 10 call attempts to the same number within any 30 minute period for any single manual call initiation and the equipment shall go on-hook for a period of not attempt and the beginning of the next attempt.

For Automatic calls to different numbers.

The equipment shall go on-hook for a period of not less than 5 seconds between the end of one attempt and the beginning of the next attempt.

For Automatically answered Incoming Calls.

Incoming calls shall be answered between 3 and 30 seconds from the start of the ringing.

For correct operation, the total of the RNs of all devices connected to a single line at anytime should not exceed 5. The RN of this Equipment is 0.5.

WARNING:

CONNECTION OF NON CERTIFIED/
APPROVED PERIPHERALS MAY RESULT
IN THE EQUIPMENT OPERATING OUTSIDE
THE NEW ZEALAND EMI STANDARDS..

Table of Contents

GETTING TO KNOW YOUR LIFEBOOK

NAMES OF THE PARTS

AND THEIR FUNCTIONS

Front features of LIFEBOOK.....	1
Side features of LIFEBOOK.....	3
Bottom features of LIFEBOOK.....	5

STATUS INDICATOR LED

Power Indicator.....	6
Battery Charging Indicator.....	6
Battery Level Indicator.....	6
Optical Drive Access Indicator.....	6
Num Lock Indicator.....	6
Caps Lock Indicator.....	6
Scroll Lock Indicator.....	6
Wireless LAN / Bluetooth Indicator.....	6

USING YOUR LIFEBOOK

RUNNING LIFEBOOK ON ITS BATTERY

Recharging the Battery.....	7
Running LIFEBOOK on its battery.....	8
Checking the power level of the battery.....	8

POWER MANAGEMENT

Power/Suspend/Resume Button	10
Suspend Mode	10
Hibernation (Save-To-Disk) Feature	11
Windows Power Management	12
Power Off	12

POWER SOURCES

Connecting the AC Adapter.....	13
Changing the battery.....	14
Power On.....	15
Power Off.....	15
Warranty Registering for Your Fujitsu LIFEBOOK	15

TROUBLESHOOTING

Identifying the Problem	16
-------------------------------	----

NOTE:

A copy of LIFEBOOK User Manual is located in your Microsoft Windows OS or you can find it in Fujitsu website at <http://hk.fujitsu.com/pc>.

You can use this LIFEBOOK User's Manual to find out more information about the functions and features of your notebook.

NAMES OF THE PARTS AND THEIR FUNCTIONS

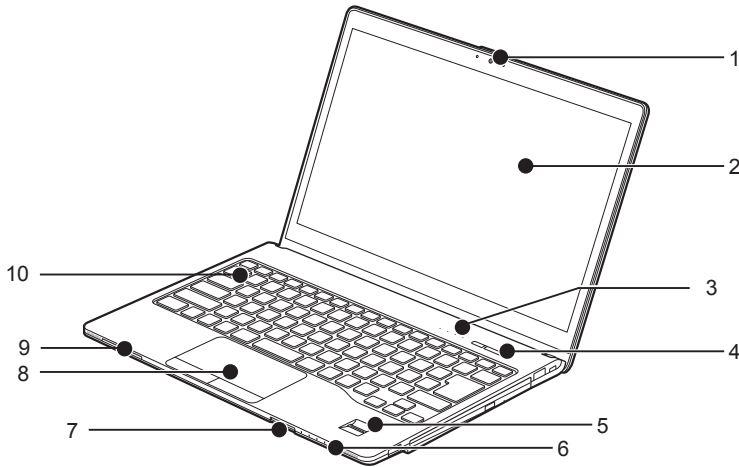

(This picture is for illustration purpose only and may look different from the actual unit)

Front features of LIFEBOOK

1. **HD Camera**
The location of the high definition camera.
2. **Display Panel**
The display screen of the notebook.
3. **Status Indicator LED**
This indicator displays operating status symbols that corresponded to specific components of your notebook.
4. **Power and Suspend/Resume Button**
This button allows you to power on or off the notebook. You can use also this button to suspend notebook activity without turning off the power to it and to resume the notebook from suspend mode.



POINT

- The phenomena described below are characteristics of LCD panels and do not indicate that LCD panels are defective.
 - The LCD screen of your notebook, composes of more than 2,350,000 picture elements (number of dots when the screen resolution is set at 1366 by 768 pixels). It was manufactured using advanced technologies. For technical reasons, LCD screen may have pixels that do not light and pixels that are always lit.
 - LCD panels may display slight varying colors and uneven density.

5. **Fingerprint Sensor**

The Fingerprint Sensor provides an alternative way to Windows logon authentication and homepages logon authentication.

6. **Status Indicator LED**

This indicator displays operating status symbols that corresponded to specific components of your notebook.

7. **SD Card Slot**

The Secure Digital (SD)/SDHC card slot allows you to install a flash memory card for data storage. Flash memory cards allow you to transfer data to and from a variety of different digital devices.

8. **Touch Pad**

It allows you to control the display cursor (mouse pointer).

9. **Smartcard Slot**

10. **Keyboard**

A full-function keyboard with dedicated Windows keys.

 **WARNING**

Spill resistant keyboard does not imply the keyboard is water-proof. If liquid is spilled onto the keyboard, power off your notebook immediately and turn the notebook upside down to drain off the liquid.

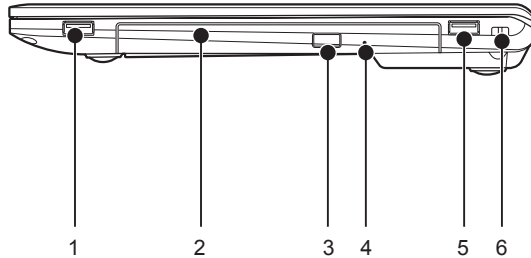

(This picture is for illustration purpose only and may look different from the actual unit)

Exterior features: Side view

■ Right view of LIFEBOOK

1. **USB 3.0 Port**
The USB 3.0 port allows you to connect Universal Serial Bus devices. USB 3.0 devices transfer data at up to 480Gbps and is backward compatible with USB 2.0 devices.
2. **Modular Bay Device**
Your notebook has a multi-purpose bay installed with a hot-swappable bay device. This installed bay device varies between country configurations. Please check with your local distributor for actual bundling. The bay device is hot-swappable because you can take out or install a bay device with other bay device options. These are sold separately.
3. **Modular Bay Eject Button**
4. **Security Hole**
5. **USB 3.0 Port**
The USB 3.0 port allows you to connect Universal Serial Bus devices. USB 3.0 devices transfer data at up to 480Gbps and is backward compatible with USB 2.0 devices.
6. **Kensington Lock**
The notebook is supplied with a pen cord which you can attach to the eyelets on the pen and on Kensington Lock of the notebook.

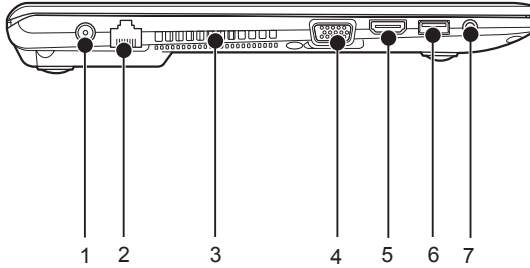

(This picture is for illustration purpose only and may look different from the actual unit)

■ Left view of LIFEBOOK

1. DC Power Jack

2. LAN Port

This Port allows you to connect to a LAN (local area network) using an optional LAN cable.

3. Air Vents

The air vents are used to cool the system to prevent overheating.

4. VGA Port

This port allows you to connect external display devices.

5. HDMI Port

You can use this port connect to a TV with HDMI-Out port for high quality video output. The HDMI-Out port supports both video and audio output.

6. USB 3.0 Port

The USB 3.0 port allows you to connect Universal Serial Bus devices. USB 3.0 evices transfer data at up to 480Gbps and is backward compatible with USB 2.0 devices.

Equipped with a USB charging function.

7. Microphone and headphone Combo Port

🔥 CAUTION

- Do not obstruct the air vents while the system is running; doing so could cause your system to overheat.
- Surface temperature may be high during and after operation. Do not touch the surface.

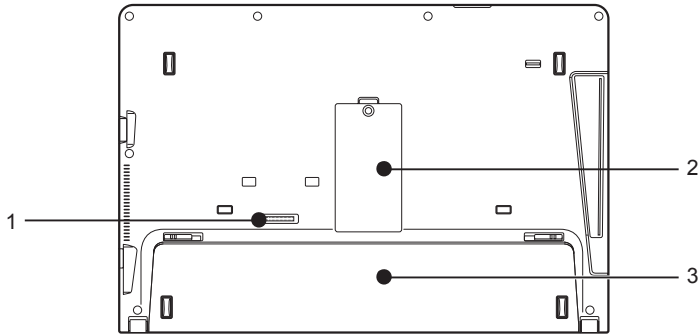

(This picture is for illustration purpose only and may look different from the actual unit)

Exterior features:

■ Bottom view of LIFEBOOK

1. **Docking Port**
The location of the expansion memory slot.
2. **Expansion RAM Module Slot**
The location of the expansion memory slot.
3. **Battery**

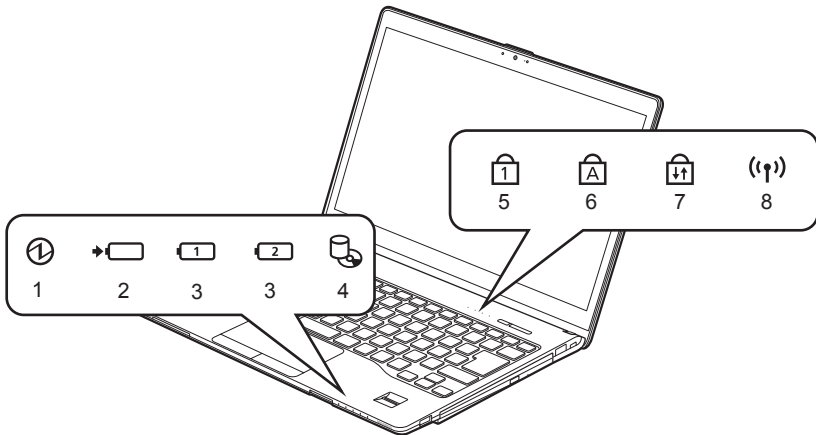

(This picture is for illustration purpose only and may look different from the actual unit)

STATUS INDICATOR LED

1. Power Indicator ()

This indicator turns on when there is power to the notebook.
It turns off when the notebook is powered off.
This indicator will blink if the notebook is put in suspend mode.

2. Battery Charging Indicator ()

This indicator turns on when internal battery is being charged.

3. Battery Level Indicator (/)

The two Battery Level Indicators state the presence of standard Li-ion battery and optional modular bay Li-ion battery.

Battery

1. refers to the standard battery
2. refers to the optional modular bay battery.
In addition, these two indicators show the remaining power of the batteries.

4. Optical Drive Access Indicator ()

This indicator turns on when an internal hard disk drive or an optical drive device or a removable disk drive is being accessed.

6. Num Lock Indicator ()

This indicator lights up when the keyboard is locked in Num Lock mode. (You can use the keyboard as a ten-digit keyboard when the Num Lock mode is turned on).



7. You can toggle the Num Lock mode by using the [] key.

Caps Lock Indicator ()

You can toggle the Caps Lock mode by using the [] key.

Scroll Lock Indicator ()

This indicator turns on when the lock mode is turned on.

8. You can toggle the Scroll Lock button by using the [] key while holding down the [] key.

Wireless Indicator ()

This indicator turns on when the wireless LAN of the notebook is being activated by user.

POINT

- Do not power off the notebook when the disk drive access indicator is shown.
- Failure to do so corrupt data on the disk as well as the installed operating system.

RUNNING LIFEBOOK ON ITS BATTERY

Recharging the battery

1. **Connect the AC adapter to your notebook**
The moment you connect an AC adapter to your notebook, the notebook begins to charge the internal standard battery pack.
2. **When the battery level indicator turns off after the battery is completely charged, (while the notebook is in off mode) disconnect the AC adapter from the notebook.**



POINT

- Before using the supplied battery pack for the very first time after purchase, remember to charge it fully. If a charged battery has not been recharged for more than a month, charge it fully before using it.
- When the battery is fully charged while the notebook is in power off mode, the Battery Charging Indicator turns off.



POINT

- When the battery is 90% or more charged, it cannot be recharged even if the AC adapter is connected. The battery can be recharged when its power level (i.e. remaining battery life) is 89% or less. This is a mechanism to protect and extend the battery life.
- When a notebook is turned off, the Battery Level LED indicator goes off immediately if the battery is completely charged.
- The chargeability of the battery degrades when it is used in an extremely hot or cold place.
- When the battery is very hot, for example, immediately after long usage of the notebook, the battery protection feature may be activated to prevent the battery from being recharged. When the temperature decreases, the notebook automatically begins to charge the battery.
- When an optional modular bay battery is installed, it is charged along with the internal standard battery. (Optional modular bay battery is applicable to selected models only.)

Running LIFEBOOK on its Battery

This section describes the steps to run the notebook on its internal standard battery.

Disconnect the AC adapter from your notebook and press the power button.

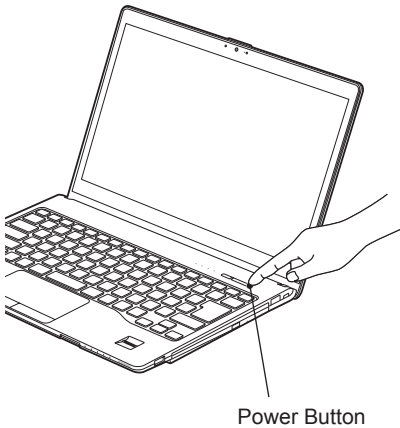

(This picture is for illustration purpose only and may look different from the actual unit)

POINT

- The power level of the battery decreases faster when it is used in cold place.
- The chargeability of the battery decreases after it has been used over a long period of time. If the battery runs down very fast, replace it with a new battery.

Checking the power level of the battery

This section describes the steps to run the notebook on its internal standard battery.

POINT

- When the power is turned off, the status display LEDs are all OFF except for during battery charging.

Battery Charging Indicator (→)

This lamp indicates charging status of battery when AC adaptor is connected to PC.

- **Blue lamp is lit**
Charging completed.
- **Amber lamp is lit**
Charging
- **Purple lamp flashes**
Charging stopped (due to battery temperature alarm, etc. [Note 1])
- **OFF**
No charging due to disconnected AC adaptor.

**POINT**

- The use of a weak battery may result in lost of data you are currently working on. When the battery runs low, connect the AC adapter to your notebook as soon as an external power source is available or immediately save the data you are working on, exit all applications and turn off the notebook.
- Accessing data on the hard disk consumes a lot of power. Therefore when the battery is weak, connect an AC adapter to the notebook before accessing data on the hard disk.
- If a battery is weak and there is no system activity, the notebook may go into standby(i.e. suspend) mode. However, if there is system activity, the notebook will go into standby mode only after the system activity has completed its processing.
- The notebook will go into standby mode when the indicator reaches 3%. This is the default setting if the notebook.

NOTE 1:

Battery temperature alarm is to stop charging with battery protection function when emperature of built-in battery pack or extended built-in battery unit becomes too high or too low due to battery heat or cooling down of the battery.

Power Management

Your Fujitsu LIFEBOOK has many options and features for conserving battery power. Some of these features are automatic and need no user intervention, such as those for the internal modem. However, others depend on the parameters you set to best suit your operating conditions, such as those for the display brightness. Internal power managements for your notebook may be controlled from settings made in your operating system, pre-bundled power management application, or from settings made in BIOS setup utility.

Besides the options available for conserving battery power, there are also some things that you can do to prevent your battery from running down as quickly. For example you can create as appropriate power saving profile, put your notebook into Suspend mode when it is not performing as operation, and you can limit the use of high power devices. As with all mobile, battery power computers, there is a trade-off between performance and power savings.

Power/Suspend/Resume Button

When your LIFEBOOK is active, the Power/Suspend/Resume button can be used to manually put your notebook into Suspend mode. Push the Power/Suspend/Resume button when your notebook is active, but not actively accessing anything, and immediately release the button. You will hear two short beeps* and your system will enter Suspend mode.

If your LIFEBOOK is suspended, pushing the Power/Suspend/Resume button returns your notebook to active operation. You can tell whether the system is Suspended by looking at the Power indicator. If the indicator is visible and not flashing, your notebook is fully operational. If the indicator is visible and flashing, your notebook is in Suspend mode. If the indicator is not visible, the power is off or your notebook is in Hibernation mode. (See *Hibernation Feature*)

* Only applicable for some models

Suspend Mode

Suspend or Standby mode in Windows saves the contents of your notebook's system memory during periods of inactivity by maintaining power to critical parts. This mode will turn off the CPU, the display, the hard drive, and all of the other internal components except those necessary to maintain system memory and allow for restarting. Your notebook can be put in Suspend mode by:

- Pressing the Power/Suspend/Resume button when your system is turned on.
- Selecting Standby from the Windows Shut Down menu.
- Timing out from lack of activity.
- Allowing the battery to reach the Dead Battery warning condition.

Your notebook's system memory typically stores the file on which you are working you are working, open application information, and any other data required to support operation from Suspend mode, your notebook will return to the point where it left off. You must see the Power.Suspend/Resume button to resume operation, and there must be as adequate power source available, or your notebook will not resume.

**POINT**

- If you are running your LIFEBOOK on battery power, be aware that the battery continues to discharge while your notebook is in Suspend mode, though not as fast as when fully operational.
- Disabling the Power/Suspend/Resume button prevents it from being used to put your LIFEBOOK in Suspend or Hibernation(Save-to Disk) mode. The resume function of the button cannot be disabled.
- The suspend or hibernation(Save-to-Disk) mode should not be used with certain PC cards. Check your PC Card documentation for more information. When PC Cards or external devices are in use, Hibernation(Save-to-Disk) mode cannot return to the exact state prior to suspension, because all of the peripheral devices will be re-initialized when the system restarts.
- If your LIFEBOOK is actively accessing information when you enter the Suspend or Hibernate (Save-to Disk) mode, changes to open files are not lost. The files are left open and memory is kept active during Suspend mode or the memory is transferred to the internal hard drive during hibernation mode.
- The main advantage of using the Hibernation(Save-to-Disk) function is that power is not required to maintain your data. This is particularly important if you will be leaving your LIFEBOOK in a suspended state for a prolonged period of time. The drawback of using Hibernation mode is that it lengthens the power down and power up sequences and resets peripheral devices.

Hibernation (Save-To-Disk) Feature

The Hibernation feature saves the contents of your LIFEBOOK notebook's system memory to the hard drive as a part of the Suspend/Resume mode. You can enable or disable this feature.

Enable or Disable the Hibernation Feature**Windows 7:**

The default settings are not enabled. To enable or disable the Hibernation feature follow these steps:

1. From the **Start** menu, select **Control Panel**
2. Select "**System and Security**" and then select "**Power Options**".
3. Select "Choose what the power button does" or "Choose what closing the lid does", then make your selections (Do Nothing, Sleep, Hibernate, or Shut Down.)

Windows 10:

1. Visit **Control Panel**.
2. Select "**System and Security**" and then select "**Power Options**".
3. Select "**Change what power button do**", and click "**Change settings that are currently unavailable**".
4. Under "**Shutdown Setting**", select the Hibernate tab. Select the box to enable or disable this feature and click "**Save changes**" to apply.

Windows Power Management

The Power Options icon located in the Windows Control Panel allows you to configure some of the power management settings. For example, you can use the Power Options to set the timeout values for turning off the display and hard disks whether you are running the notebook on battery power or one of the adapters.

Restarting The System

If your system is on and you need to restart it, be sure that you use the following procedure.

Windows 7

If your system is on and you need to restart it, be sure that you use the following procedure.

1. Click the **Start** button, and then move the mouse over the right arrow.
2. Select the desired action from the list.

Windows 10

1. Click the Windows icon
2. Click the **Power**, and select **Restarting** from the list.

IMPORTANT

Turning off your notebook without exiting Windows or turning on your notebook within 10 seconds of the notebook being shut off may cause an error when you start the next time.

Power Off

Before turning off power, check that the hard drive/optical drive access indicator is off. If you turn off the power while accessing a disk there is a risk of data loss. To ensure that your notebook shuts down without error, use the Windows shut down procedure.

CAUTION

Be sure to close all files, exit all applications, and shut down your operating system prior to turning off the power. If files are open when you turn the power off, you will lose any changes that have not been saved, and may cause disk errors.

Using the correct procedure to shut down from Windows allows your notebook to complete its operations and turn off power in the proper sequence to avoid errors. The proper sequence is:

Windows 7

1. Click the **Start** button, and then Click **Shut Down**.
2. Select the **Shut Down** option from within the Windows Shut Down dialog box.
3. Click **OK** to shut down your notebook.

Windows 10

1. Click the Windows icon
2. Click the **Power**, and select **Shut down** from the list.

If you are going to store your notebook for a month or more see Care and Maintenance Section.

Power Sources

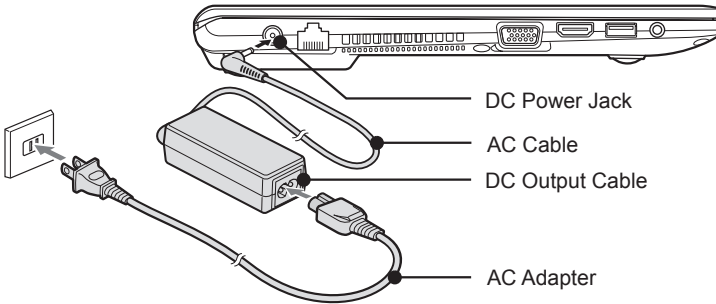

(This picture is for illustration purpose only and may look different from the actual unit)

Connecting the AC Adapter

The AC adapter provides power for operating your notebook and charging the batteries.

Connecting the AC Adapter

1. Plug the DC output cable into the DC power jack of your notebook.
2. Plug the AC adapter into an AC electrical outlet. (Above Figure)



POINT

- The Li-ion battery is not charged at the point of purchase. Remember to connect an AC adapter to your notebook to charge it when you use it for the first time.

CHANGING THE BATTERY

WARNING

- Before changing the battery pack, turn off the notebook and disconnect the AC adapter from it. To avoid shock hazards and damage to your notebook, be careful not to touch internal components of the notebook, including the battery connector.

You can install an optional battery module.

1. Turn off the notebook and disconnect the AC adapter from it.
2. Close the LCD panel and place the notebook upside down.

IMPORTANT

- Close the LCD panel gently. Do not exert excessive pressure to it. Failure to do so may damage the LCD panel.

3. Unlock the battery cover.

While pressing the latches that lock the battery, push the battery outwards in the direction of the arrow as shown.

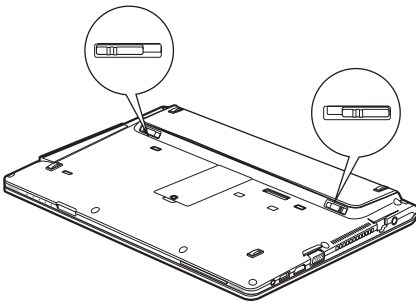

4. Open the battery cover.

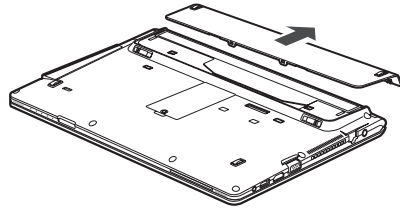

5. Remove the battery pack.

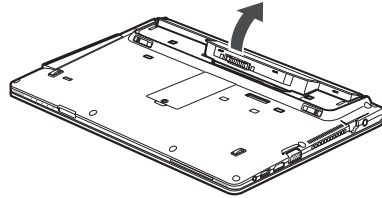

6. Install a new battery pack.

Press the latches on the battery pack and align it to fit into the battery compartment of the notebook. When the battery falls in place, push the battery inwards as shown and releases the latches.

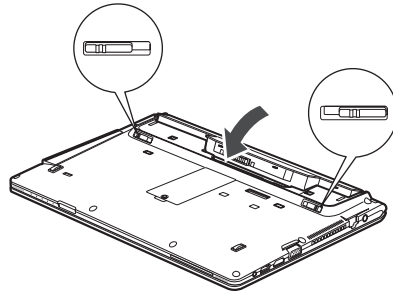

IMPORTANT

- After removing the battery, please take necessary precautions to prevent it from being shorted. For example, you can seal the connector ends with insulating tape. After removing the battery pack, do not mix it with other types of battery. The internal battery pack contains recyclable material.

Power on

Power/Suspend/Resume button

You can use the Power/Suspend/Resume button to turn on your notebook. Once you have connected an AC adapter to the notebook or charged the internal Lithium ion battery, you can power on your notebook.



POINT

When you turn on your notebook, be sure you have a power source connected to it. This means that at least one battery is installed and charged or that the AC adapter is connected and has power.

You can press the Power/Suspend/Resume button to turn off the notebook. After you have finished working on the notebook, you can either leave it in Standby (i.e. suspend) mode or turn it off.



CAUTION

Do not carry the notebook around when it is still powered on. Do not subject the notebook to shocks and vibrations. Failure to do so may damage the notebook.

When you power on your notebook, it will perform a Power On Self Test (POST) to check the internal parts and configuration for normal functionality. If an error is found, your notebook will emit an audio warning and/or show an error message.

After satisfactory completion of the Power On Self Test (POST), your notebook will load your operating system.

Power off

Before turning off the power, check that the Hard Drive, Optical Disk access and PC Card indicators are all Off. If you power off the notebook when it is accessing the disk or PC Card, data may be lost or corrupted. To power off the notebook, always shut down the notebook properly using the Windows shutdown procedure.



CAUTION

Remember to close all files, exit all applications and shut down the operating system prior to turning off the power using the power button. If documents are opened when the notebook is turned off, data may be lost and this may result in disk errors.

Remember to use the correct procedure to shut down the notebook. The proper procedure is:

Windows 7

1. Click the **Start** button, and then Click Shut Down.
2. Select the **Shut Down** option from within the Windows Shut Down dialog box.
3. Click **OK** to shut down your notebook.

Windows 10

1. Click the Windows icon
2. Click the **Power**, and select **Shut down** from the list.

Warranty Registering for Your Fujitsu LIFEBOOK

How do I register?

You can register your LIFEBOOK by going to our website:

<http://ww3.fujitsu-pcap.com.hk/SUP/>

Troubleshooting

Your Fujitsu LIFEBOOK is sturdy and subject to few problems in the field. However, you may encounter simple setup or operating problems that you can solve on the spot, or problems with peripheral devices, that you can solve by replacing the device. The information in this section helps you isolate and resolve some of these straightforward problems and identify failures that require service.

Identifying the Problem

If you encounter a problem that you are having difficulty in solving, go through the following procedure before pursuing further troubleshooting.

1. Turn off your notebook.
2. Make sure the AC adapter is plugged into your notebook and to an active AC power source.
3. Make sure that any card installed in the PC Card slot is seated properly. You can also remove the card from that slot, thus eliminating it as a possible cause of failure.
4. Make sure that any devices connected to the external connectors are plugged in properly. You can also disconnect such devices, thus eliminating them as possible causes of failure.
5. Turn on your notebook. Make sure it has been off at least 10 seconds before you turn it on.
6. Go through the boot sequence.

Before you place the call, you should have the following information ready so that the customer support representative can provide you with the fastest possible solution:

- Product name
- Product configuration number
- Product serial number
- Purchase date
- Conditions under which the problem occurred
- Any error messages that have occurred
- Hardware configuration
- Type of device connected, if any

See the Configuration Label on the bottom of your notebook for configuration and serial number.



POINT

- If you keep notes about what you have tried, your support representative may be able to help you more quickly by giving additional suggestions over the phone.
- Do not return a failed notebook to your supplier until you have talked to a support representative.